

WATER METER DOWNSIZING

- ▶ Sizing the New Meter
- ▶ Water Meter
- ▶ Downsizing Hardware
- ▶ Downsizing Larger
- ▶ Meters

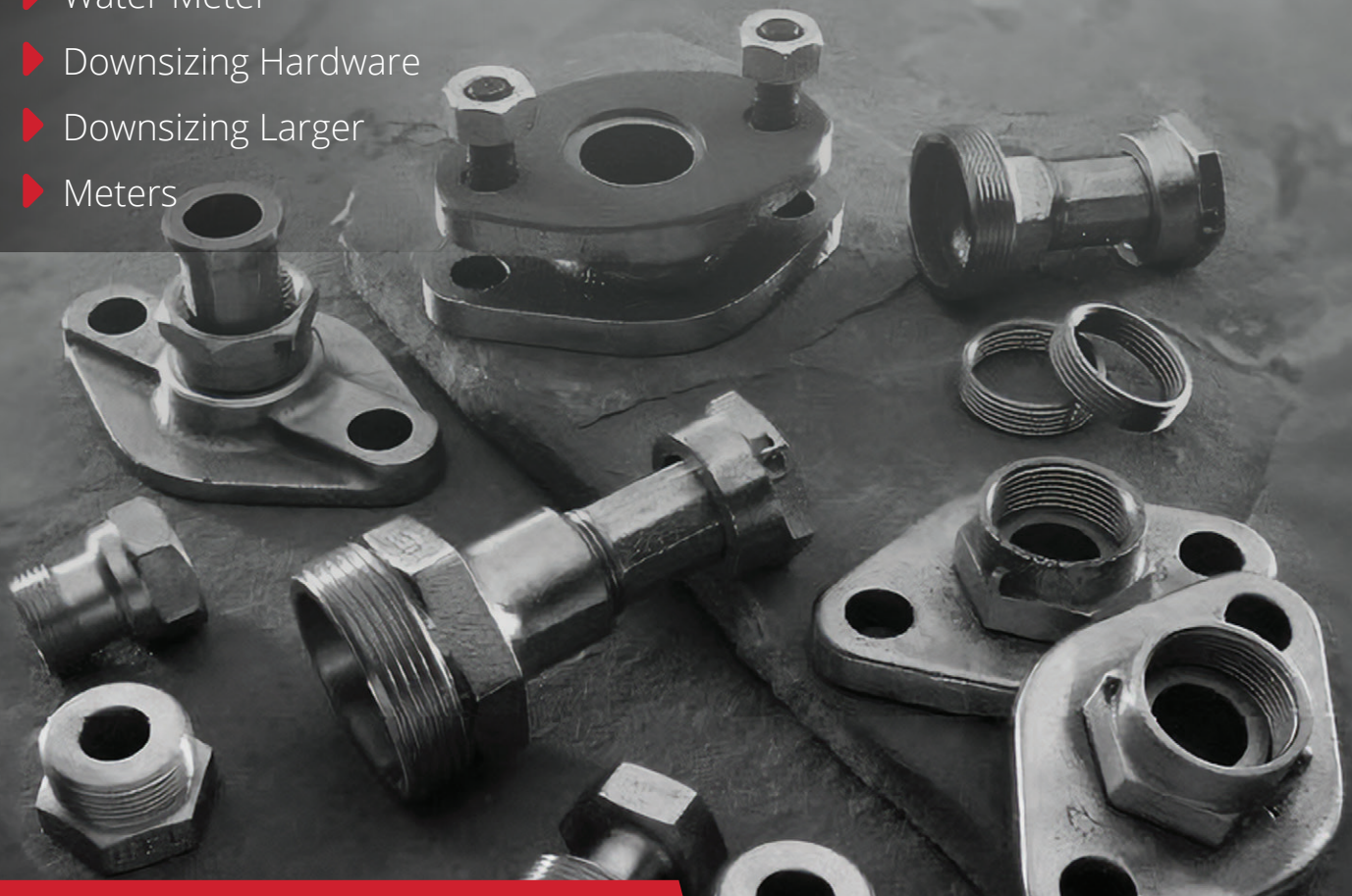

LEAD-FREE

HISTORY

The history of Red Hed goes back to 1921 with its beginning in South Boston, Massachusetts.

From manufacture of the very first valve, through 1970 when the company was first sold, each valve was hand wrapped in brown mill paper and boxed in wood packing boxes for shipment. Each handmade valve was assembled and tested before ever leaving the production floor. To distinguish itself from its competitors' the head of each valve was painted red, thus the name Red Hed Manufacturing. To this day Red Hed continues the tradition started in 1921 of manufacturing the finest brass waterworks valves and components in our industry.

Henry Lawton (owner of Lawton Manufacturing) purchased Red Hed in 1970 and it was merged with his company. He moved Red Hed from Boston to its current location in Rhode Island where the company continued to fabricate Red Hed brass waterworks valves in the same manner as its predecessors. Henry focused his efforts on the Red Hed product line and over the next few decades the company became known for its innovative designs and quality craftsmanship.

Having a reputation as a leader in adaptation, downsizing and producing valves that just did not fail in the field allowed Red Hed to grow and prosper. The invention and patenting of the Space Saver flange opened new markets for Red Hed. The firm continued to grow, selling Red Hed product lines throughout the United States and Canada. In 2006, Red Hed demonstrated that its creativity continues by introducing the first line of true Lead-Free brass products. The small shop has grown and now enjoys the reputation for fast turn-around and the same great quality.

Red Hed's reputation for the best brass valve in the industry remains intact. The spirit of past owners, engineers and machinists who took great pride in their work, is proudly continued by our strong work ethic and integrity: "It doesn't leave the plant until it is 100%." Red Hed has adapted, evolved and met the challenges of the various generations. We look forward to the next 90 years being just as challenging and rewarding as the first 90 years.

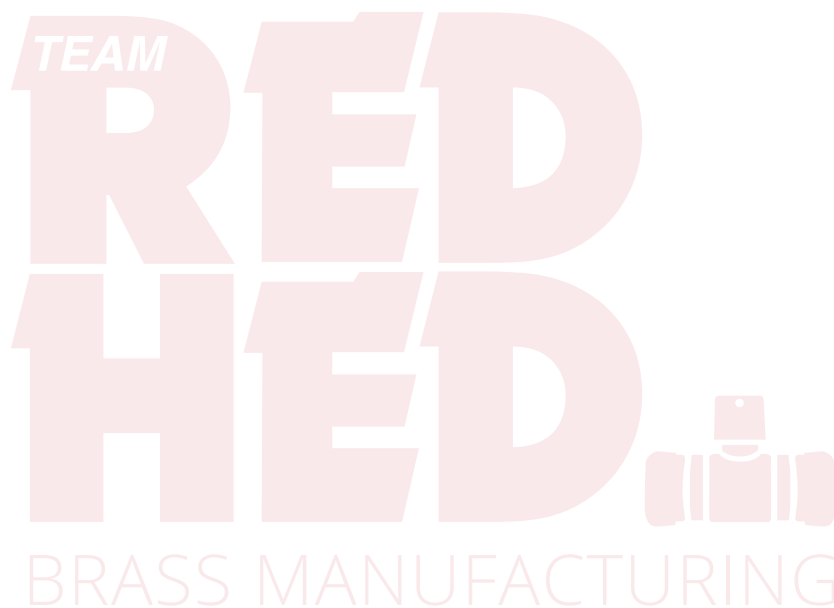

TABLE OF CONTENTS

Water Meter Downsizing

Bronze Water Meter Hardware.....	4
Why Downsize	4
Benefits of a Properly-Sized Meter	4
Boston Water & Sewer Commission.....	4
Getting Started	5
Determine Which Size Water Meter You Need	5

Sizing The New Meter

Data Logging	6
Using Plumbing Fixture Values.....	6, 8-10
Determine Your Required GPM	7
Some Things to Remember	11

Water Meter Downsizing Hardware

Meter Spacing Pieces.....	12
Water Meter Couplings.....	12
Replace a 5/8" x 3/4" meter with a 5/8" meter.....	13
Replace a 3/4" meter with a 5/8" meter	14
Replace a 1" meter with a 5/8" meter	15
Replace a 1" meter with a 5/8" x 3/4" meter.....	16
Replace a 1" meter with a 3/4" meter	17
Replace a 3/4" meter with a 5/8" x 3/4" meter.....	18
Replace a 1-1/2" screwed-end meter with a 1" meter	19
Replace a 2" screwed-end meter with a 1" meter	20
Replace a 1-1/2" meter with a 1" meter	21
Replace a 2" meter with a 1-1/2" meter.....	22
Replace a 2" meter with a 1" meter	23
Replace a 3" turbine meter with a 1" meter	24
Replace a 2" turbine meter with a 2" compound meter.....	25
Standard Meter Flanges.....	26
Downsizing Reference Chart.....	27
New Connection Reference Chart.....	27
High Density Polyethylene Pre-Fabricated Meter Pits	28
5/8" - 1" Meter Pit Cover	29
1-1/2" - 2" Meter Pit Cover	29

Downsizing Larger Meters

The Space Saver Flange.....	30
Re-Sizing the Application	31
Space Saver Flanges.....	32

WATER METER DOWNSIZING

Bronze Water Meter Hardware

Red Hed Manufacturing offers you the right kind of high quality hardware you need for either straight connecting of piping and meters, or downsize connecting. Our Bronze Meter Flanges, Reducing Meter Couplings, Meter Pits and Meter Downsizing Adapters allow you to meet your meter-connecting requirements with bronze, never-rust fittings crafted to exact Lead-Free Red Hed standards.



Why Downsize?

At the time that many water meters were first installed, their size was based on anticipated water needs of customers and/or the fire department. Water usage at a property can vary over the years due to changes in the number of occupants or in the type of business, as occupants con-serve more water, and through changes in usage patterns in the home and/or business. As a result, your water meter may no longer be the correct size to meet your current water needs.

Benefits of a Properly-Sized Meter

Properly sized water meters can benefit you in a many ways, such as:

- Increased accuracy
- Lower failure rate
- Less maintenance
- Sub-metering in a multi-dwelling unit or business park
- Lower base charge per billing cycle (check with local water provider as this may vary from place to place)

Boston Water & Sewer Commission:

As of May 17, 1991 the Red Hed Space Saver Flange saved The City of Boston more than 429,905 gallons per day of water... simply by downsizing. The increased accuracy of the more than 400 downsized meters (1-1/2" and larger) dramatically reduced unaccounted for water and saved \$2 million annually to offset the commission's rate revenue requirements.

LEAD-FREE

WATER METER DOWNSIZING

Getting Started

Determine Which Size Water Meter You Need

To determine whether downsizing is right for you, do the following:

1. Determine the type of water service that serves your property.
 - Fire - Used for fire protection i.e. fire sprinklers, fire hydrants etc.
 - Domestic - Drinking water, flushing, washing, etc., as well as business and industrial uses.
 - Fire and Domestic - Combined service which supplies water for both domestic and fire protection uses.
2. Determine the maximum water flow on your property in gallons per minute. (Remember to include the maximum designed fire flow, if applicable.)
3. Using the matrix on below, determine if downsizing your meter is right for you. After you have selected the meter that meets your flow requirements you're ready to downsize!

METER SIZE	DOMESTIC METER FLOW	DOMESTIC COMPOUND FLOW	FIRE METER FLOW
5/8"	.11-25 GPM	N/A	N/A
5/8" x 3/4"	.11-25 GPM	N/A	N/A
3/4"	.11-35 GPM	.11-25 GPM	.11-25 GPM
1"	.4-55 GPM	.4-55 GPM	.4-55 GPM
1-1/2"		.5-200 GPM	
2"		.5-200 GPM	
3"		1-500 GPM	
4"		1.5-1000 GPM	1.5-1000 GPM
6"		3.0-2500 GPM	3.0-2000 GPM
8"		4.0-2700 GPM	4.0-3500 GPM
10"		5.0-4000 GPM	5.0-5500 GPM

For example: If you have a six inch water meter supplying domestic water for a commercial account let's assume your base service charge is \$100 per month. You then calculate that your maximum water flow on the property is less than 220 gallons per minute. A three inch meter will supply you with more than enough water. If the three inch meter service charge is a cost of \$32.00 a month - therefore you have a cost savings of 68%, or \$816.00 per year.

LEAD-FREE

SIZING THE NEW METER

Determining Your Required GPM

Data Logging

Should you be uncertain as to what your new GPM requirements are, Red Hed Manufacturing can help! One way is to data log the old meter. Red Hed can either come to your location and install the Meter Master device, or you can install the rented equipment yourself.

Designed for demand monitoring and assisting in determining proper meter sizing, rate structuring, leak detection, and more. The Meter Master Rate of Flow Recorder is fast and easy to set-up with pushbutton operation and no PC required in the field! The compact unit makes it an easy fit regardless of where the existing meter is installed. Contact Red Hed Manufacturing for more details.



Using Plumbing Fixture Values

Another way to determine your GPM flow requirement is by using a “plumbing fixture value” chart. Simply count the water-using fixtures that the new meter will be supplying and enter those values into the chart on the next page (Figure A). After some simple calculations you will have a better idea of your GPM needs. The following chart (Figure A) represents each individual plumbing fixture value as if each fixture was operated independently at 35 PSI inlet pressure. A bathtub for example flows at a rate of 8 gallons per minute without any interference from other fixtures. As more fixtures are present, the probability of flow decreases. When encountering devices or fixtures not listed, the demand in gallons per minute should be determined and added to the total fixture count. Start by simply counting your fixtures, enter them into the chart, and then multiply across to get your total for that individual fixture. When you have counted all of your fixtures, total the number of points you have counted to find your Combined Plumbing Fixture Value.

LEAD-FREE

SIZING THE NEW METER

Determining Your Required GPM

Figure A

FIXTURE	FIXTURE VALUE	X	NUMBER OF FIXTURES	=	TOTAL
Bathtub	8	X		=	
Bedpan Washers	10	X		=	
Combination Sink & Tray	3	X		=	
Dental Unit	1	X		=	
Dental Lavatory	2	X		=	
Drinking Fountain	2	X		=	
Kitchen Sink					
1/2" Connection	2	X		=	
3/4" Connection	4	X		=	
Lavatory					
3/8" Connection	3	X		=	
1/2" Connection	7	X		=	
Shower Head (shower only)	4	X		=	
Service Sink					
1/2" Connection	3	X		=	
3/4" Connection	7	X		=	
Urinal					
Pedestal Flush Valve	35	X		=	
Wall or Stall	12	X		=	
Wash Sink (each set of faucets)	4	X		=	
Water Closet					
Flush Valve	35	X		=	
Tank Type	3	X		=	
Dishwasher					
1/2" Connection	4	X		=	
3/4" Connection	10	X		=	
Commercial (nominal)	15	X		=	
Washing Machine					
1/2" Connection	5	X		=	
3/4" Connection	12	X		=	
1" Connection	25	X		=	
Hose (50' length wash down)					
1/2" Connection	6	X		=	
5/8" Connection	9	X		=	
3/4" Connection	12	X		=	

SIZING THE NEW METER

Using Plumbing Fixture Values

Now that you have calculated your Combined Fixture Value Total, compare that number to Figure B to determine your gallons per minute flow requirement. It may be necessary to round to the nearest whole number (up or down) on the chart to determine your gallons per minute requirement.

Figure B

Chart I

Country Clubs, Hospitals, Nursing Homes, Hotels, Office Buildings, Schools, Shopping Centers, Restaurants

FIXTURE VALUE	PROBABLE GPM FLOW
10	–
20	–
25	–
40	–
50	35
75	43
100	50
125	55
150	57
200	62
250	67
300	72
350	77
400	82
450	86
500	90
550	94
600	98
650	102
700	106
750	110
800	112
900	117
1,000	122
1,100	127
1,200	131
1,300	133
1,400	136
1,500	138
2,000	140
3,000	156

Chart II

Apartments, Condominiums, Dormitories, Trailer Parks, Homes, Motels

FIXTURE VALUE	PROBABLE GPM FLOW
10	10
20	18
25	20
40	21
50	22
75	23
100	24
125	26
150	28
200	30
250	33
300	37
350	39
400	42
450	44
500	46
550	50
600	52
650	54
700	56
750	58
800	59
900	61
1,000	62
1,100	64
1,200	66
1,300	68
1,400	69
1,500	70
2,000	72
3,000	76

SIZING THE NEW METER

Using Plumbing Fixture Values

Figure B (continued)

Chart I

Country Clubs, Hospitals, Nursing Homes, Hotels, Office Buildings, Schools, Shopping Centers, Restaurants

FIXTURE VALUE	PROBABLE GPM FLOW
4,000	162
5,000	168
6,000	174
7,000	180
8,000	186
9,000	192
10,000	198
11,000	204
12,000	210
13,000	216

Chart II

Apartments, Condominiums, Dormitories, Trailer Parks, Homes, Motels

FIXTURE VALUE	PROBABLE GPM FLOW
4,000	82
5,000	88
6,000	94
7,000	100
8,000	108
9,000	116
10,000	122
11,000	128
12,000	134
13,000	140

Under Pressure?

As mentioned above both charts are based on a working pressure of 35 PSI. Water pressure has a significant influence on the gallon per minute flow of the application. The chart below shows how important factoring water pressure into your calculations when sizing your new meter.

Variations in Flow Using a 50 Foot Garden Hose

Figure C

FIXTURE VALUE	PROBABLE GPM FLOW
10	7
20	9
30	11
40	13
50	15
70	22
100	22

SIZING THE NEW METER

Using Plumbing Fixture Values

Due to the variation shown in Figure C, we must compensate for the PSI variation in any application. Apply the multiplication factors below (Figure D) after completing the conversion of Fixture Values into Gallons Per Minute, this will give you the Compensated Flow Demand.

Figure D

FIXTURE VALUE	PROBABLE GPM FLOW
20	0.74
30	0.92
35	1.00
40	1.07
50	1.22
60	1.34
70	1.46
80	1.57
90	1.68
100	1.78

Example: A probable flow demand of 50 GPM was calculated. The application has an inlet pressure of 40 PSI. Using Figure C, a multiple factor of 1.07 should be used to compute the adjusted flow requirement.

$$50 \text{ GPM} \times 1.07 = 53.5 \text{ GPM Compensated Flow Demand}$$

Now that we have determined your GPM flow requirement we can use the chart below to select the desired meter with a GPM of at least 42.8 GPM. In this case a 1" meter will be sufficient for this application.

METER SIZE	DOMESTIC METER FLOW	DOMESTIC COMPOUND FLOW	FIRE METER FLOW
5/8"	.11-25 GPM	N/A	N/A
5/8" x 3/4"	.11-25 GPM	N/A	N/A
3/4"	.11-35 GPM	.11-25 GPM	.11-25 GPM
1"	.4-55 GPM	.4-55 GPM	.4-55 GPM
1-1/2"		.5-200 GPM	
2"		.5-200 GPM	
3"		1-500 GPM	
4"		1.5-1000 GPM	1.5-1000 GPM
6"		3.0-2500 GPM	3.0-2000 GPM
8"		4.0-2700 GPM	4.0-3500 GPM
10"		5.0-4000 GPM	5.0-5500 GPM

PLEASE NOTE: Data Logging is preferable and will always be more accurate than calculating flow requirements using the Plumbing Fixture Value method.

SIZING THE NEW METER

Some Things to Remember

AWWA Meter Lay Lengths

METER LENGTH	LAY LENGTH
5/8"	7-1/2"
5/8" x 3/4"	7-1/2"
3/4"	9"
1"	10-3/4"
1-1/2"	13"
2"	17"

Common Fraction to Decimal Conversions

1/16" = 0.0625	3/16" = 0.1875	5/16" = 0.3125	7/16" = 0.4375
1/8" = 0.125	3/8" = 0.3750	5/8" = 0.6250	7/8" = 0.8750
1/4" = 0.25	1/2" = 0.50	3/4" = 0.75	1 = 1.000

AWWA & Electrical Grounding

AWWA opposes the grounding of electrical systems to pipe systems conveying drinking water to customer's premises. The National Electric Code (NEC) requires that "continuity of the grounding path or bonding connection to interior piping shall not rely on water meters". Most utilities require permanent grounding strapping around meters to prevent accidents to workers changing meters. All meters should be permanently ground strapped to avoid accidents.

LEAD-FREE

WATER METER DOWNSIZING HARDWARE

Meter Spacing Pieces

Red Hed meter spacing pieces are made of durable schedule 80 PVC and are designed to take the place of a water meter either before the meter has been installed to allow for correctly spaced plumbing, pressure testing the supply line, or if a meter has been temporarily removed for accuracy testing.



PRODUCT NUMBER	METER SIZE	LAY LENGTH	QUANTITY TO USE
RH35000	5/8"	7-1/2"	1
RH35001	5/8" x 3/4"	7-1/2"	1
RH350011	3/4"	9"	1
RH35002	1"	10-3/4"	1

WATER METER DOWNSIZING HARDWARE

Water Meter Couplings

Screwed-End Meter Couplings

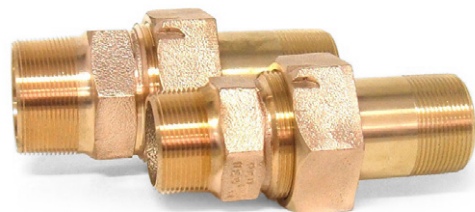

PRODUCT NUMBER	METER SIZE	CONNECTION TYPE	QUANTITY TO USE
RH13014	1-1/2"	Female Thread	2 Each
RH13015	2"	Female Thread	2 Each

For use with screwed-end meters only.

LEAD-FREE

WATER METER DOWNSIZING HARDWARE

Replace a 5/8" x 3/4" meter with a 5/8" meter

Flush Thread Bushings



5/8" Water Meter

5/8" & 5/8" x 3/4" Lay Length = 7-1/2"



PRODUCT NUMBER	NEW METER SIZE	OLD METER SIZE	CONNECTION TYPE	QUANTITY TO USE
RH1450	5/8"	5/8" x 3/4"	Meter Thread	2 Each

All meter hardware is shipped with gaskets.

LEAD-FREE

WATER METER DOWNSIZING HARDWARE

Replace a 3/4" meter with a 5/8" meter

Meter Downsizing Adapters

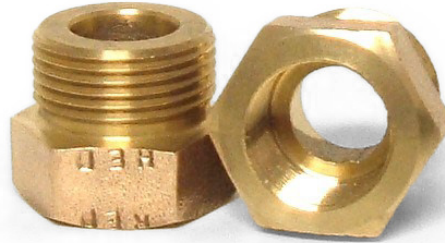

5/8" Water Meter

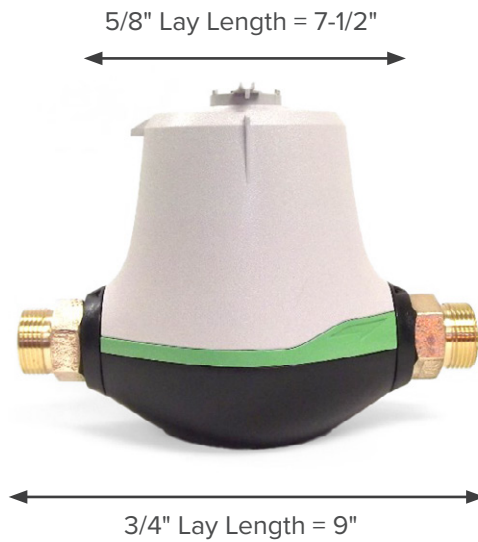

PRODUCT NUMBER	NEW METER SIZE	OLD METER SIZE	CONNECTION TYPE	QUANTITY TO USE
RH1401	5/8"	3/4"	Meter Thread	2 Each

All meter hardware is shipped with gaskets.

LEAD-FREE

WATER METER DOWNSIZING HARDWARE

Replace a 1" meter with a 5/8" meter

Meter Downsizing Adapters

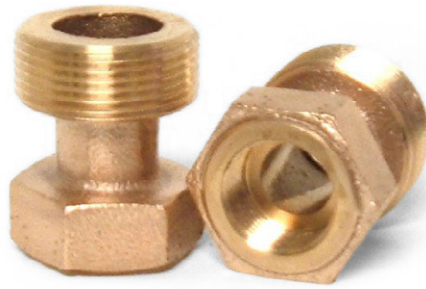

5/8" Water Meter

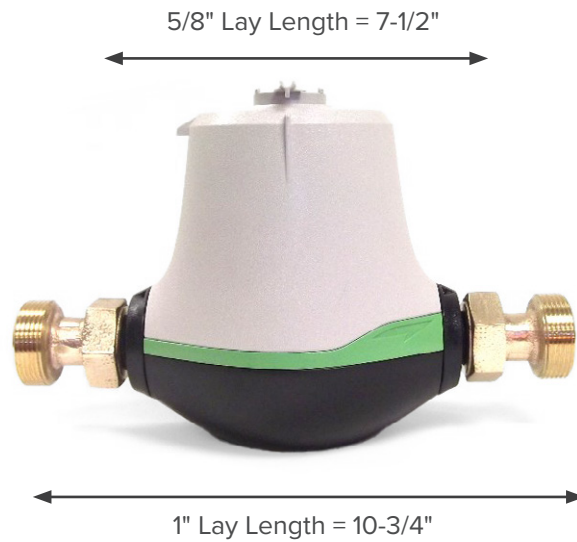

PRODUCT NUMBER	NEW METER SIZE	OLD METER SIZE	CONNECTION TYPE	QUANTITY TO USE
RH1402	5/8"	1"	Meter Thread	2 Each

All meter hardware is shipped with gaskets.

LEAD-FREE

WATER METER DOWNSIZING HARDWARE

Replace a 1" meter with a 5/8" x 3/4" meter

Meter Downsizing Adapters

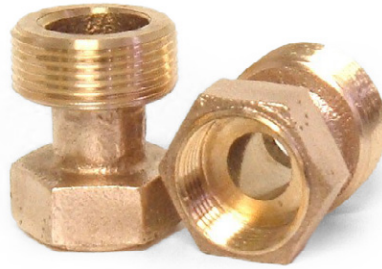

5/8" x 3/4" Water Meter

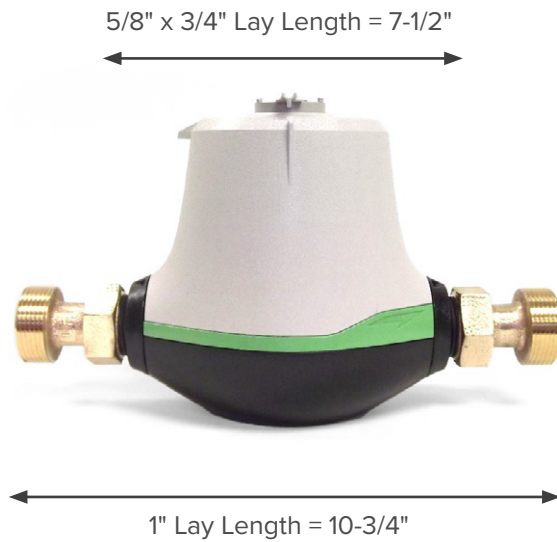

PRODUCT NUMBER	NEW METER SIZE	OLD METER SIZE	CONNECTION TYPE	QUANTITY TO USE
RH1412	5/8" x 3/4"	1"	Meter Thread	2 Each

All meter hardware is shipped with gaskets.

LEAD-FREE

WATER METER DOWNSIZING HARDWARE

Replace a 1" meter with a 3/4" meter

Meter Downsizing Adapters

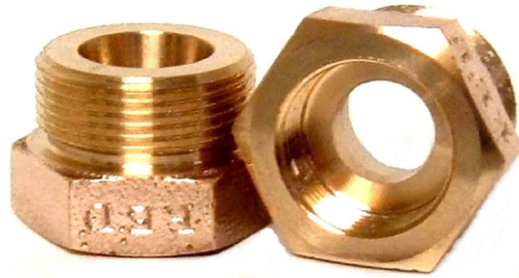

3/4" Water Meter

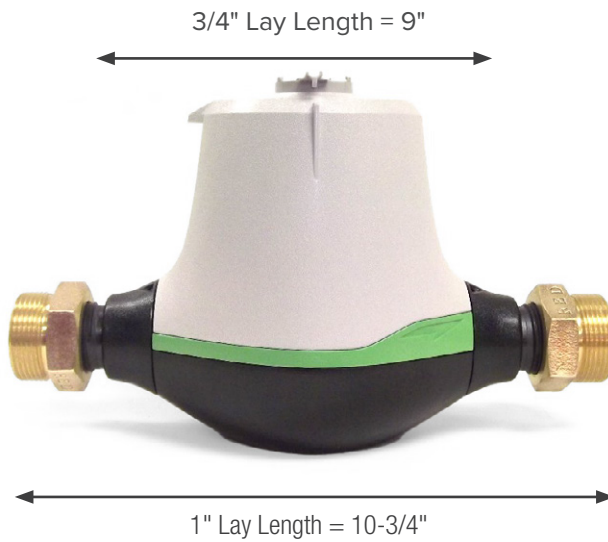

PRODUCT NUMBER	NEW METER SIZE	OLD METER SIZE	CONNECTION TYPE	QUANTITY TO USE
RH1430	3/4"	1"	Meter Thread	2 Each

All meter hardware is shipped with gaskets.

LEAD-FREE

WATER METER DOWNSIZING HARDWARE

Replace a 3/4" meter with a 5/8" x 3/4" meter

Meter Downsizing Adapters



5/8" x 3/4" Water Meter

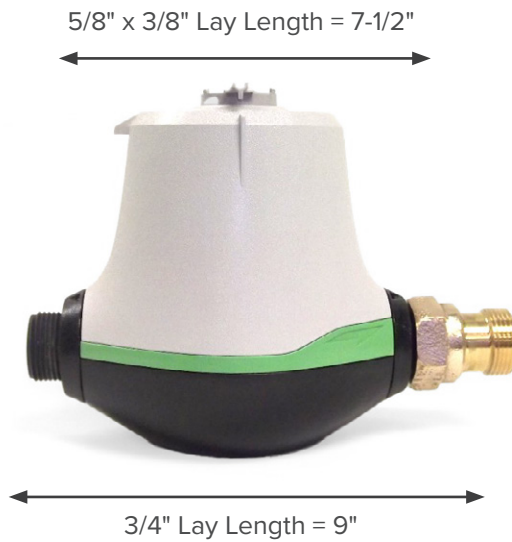

PRODUCT NUMBER	NEW METER SIZE	OLD METER SIZE	CONNECTION TYPE	QUANTITY TO USE
RH1425	5/8" x 3/4"	3/4"	Meter Thread	1 Each

LEAD-FREE

WATER METER DOWNSIZING HARDWARE

Replace a 1-1/2" screwed-end with a 1" meter

Meter Downsizing Adapters

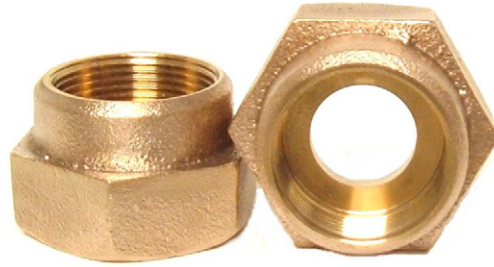

1" Water Meter

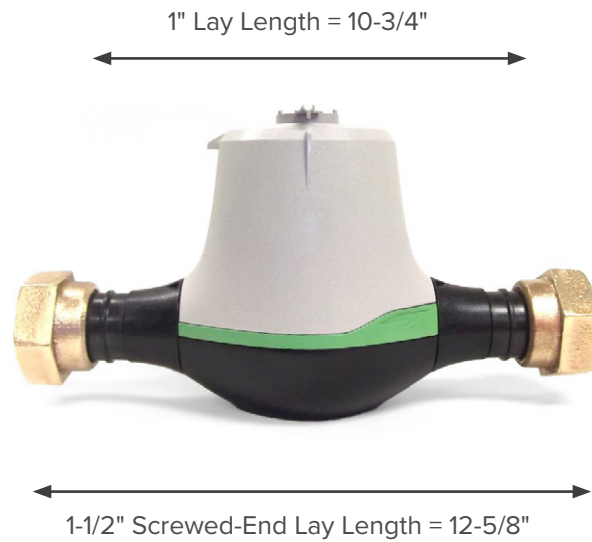

PRODUCT NUMBER	NEW METER SIZE	OLD METER SIZE	QUANTITY TO USE
RH130402P	1"	1-1/2" Screwed-End	1 Pack

All meter hardware is shipped with gaskets.

LEAD-FREE

WATER METER DOWNSIZING HARDWARE

Replace a 2" screwed-end with a 1" meter

Meter Downsizing Adapters



1" Water Meter

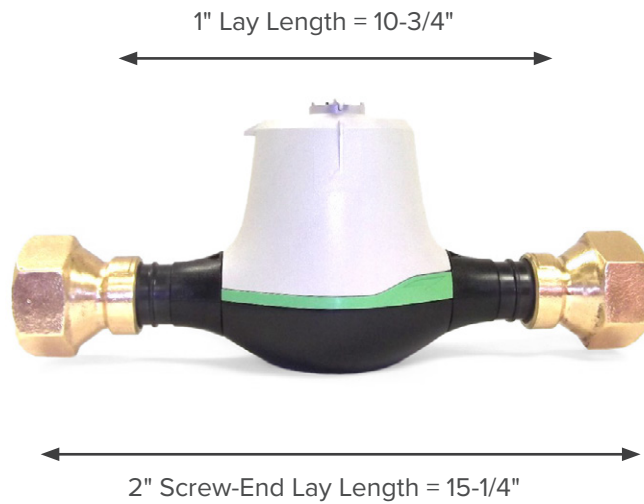

PRODUCT NUMBER	NEW METER SIZE	OLD METER SIZE	QUANTITY TO USE
RH130502P	1"	2" Screwed-End	1 Pack

All meter hardware is shipped with gaskets.

LEAD-FREE

WATER METER DOWNSIZING HARDWARE

Replace a 1-1/2" meter with a 1" meter

Meter Downsizing Flanges

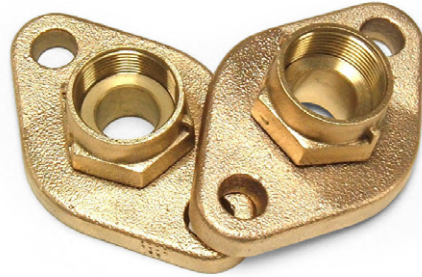

1" Water Meter

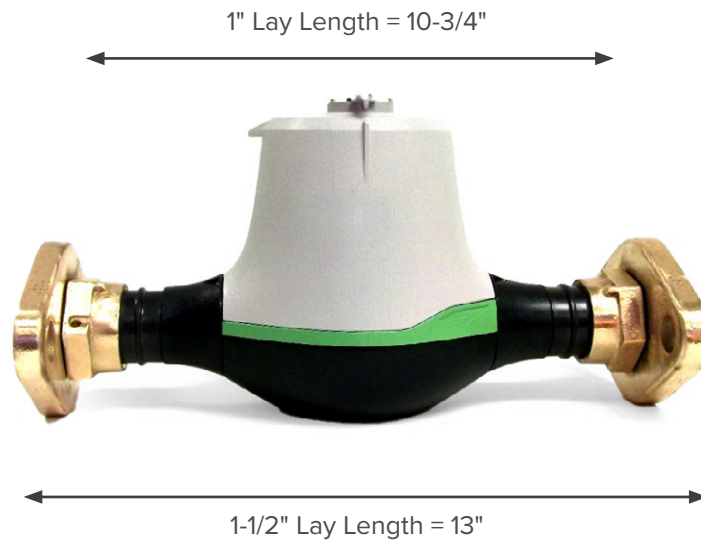

PRODUCT NUMBER	NEW METER SIZE	OLD METER SIZE	CONNECTION TYPE	QUANTITY TO USE
RH200402P	1"	1-1/2"	Flange x Meter Swivel	1 Pack

All meter flanges are shipped with bolts & gaskets.

LEAD-FREE

WATER METER DOWNSIZING HARDWARE

Replace a 2" meter with a 1-1/2" meter

Meter Downsizing Flanges

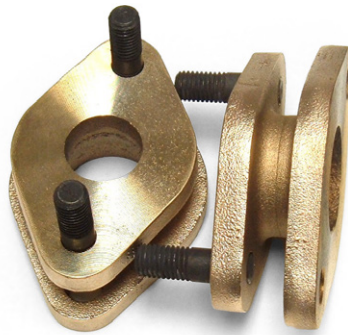

1-1/2" Water Meter

1-1/2" Lay Length = 13"

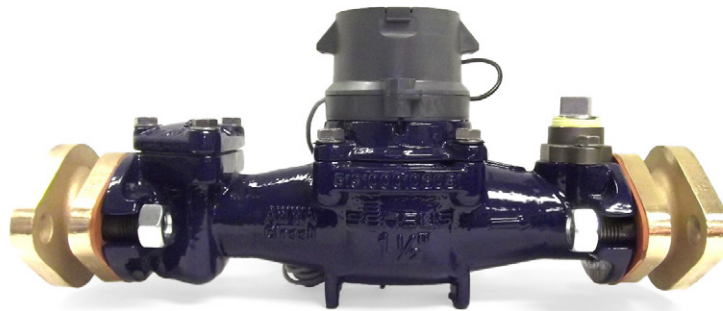

2" Lay Length = 17"



PRODUCT NUMBER	NEW METER SIZE	OLD METER SIZE	CONNECTION TYPE	QUANTITY TO USE
RH200504P	1-1/2"	2"	Flange x Flange	1 Pack

All meter flanges are shipped with bolts & gaskets.

LEAD-FREE

WATER METER DOWNSIZING HARDWARE

Replace a 2" meter with a 1" meter

Meter Downsizing Flanges

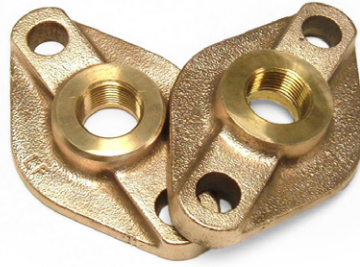

1" Water Meter

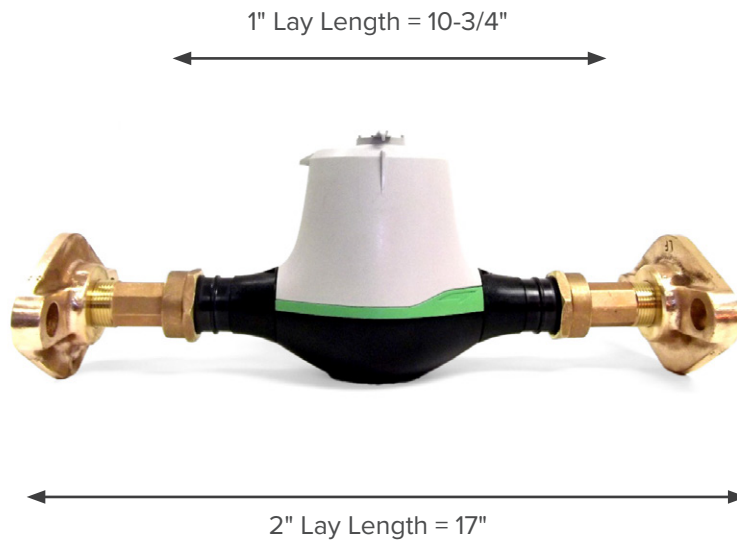

PRODUCT NUMBER	NEW METER SIZE	OLD METER SIZE	CONNECTION TYPE	QUANTITY TO USE
RH200201P	1"	2"	Flange x FEIP Thread	1 Pack

**This product for use with standard meter couplings.
All meter flanges are shipped with bolts & gaskets.**

LEAD-FREE

WATER METER DOWNSIZING HARDWARE

Replace a 3" turbine meter with a 1" meter

Meter Downsizing Flanges



1" Water Meter

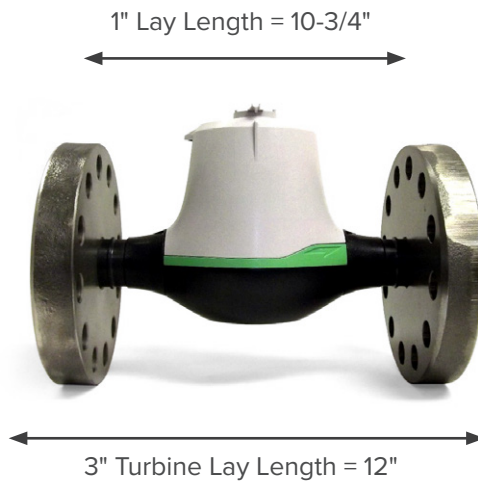

PRODUCT NUMBER	NEW METER SIZE	OLD METER SIZE	QUANTITY TO USE
RHFLSP130701	1"	3" Turbine	2 Each

Meter flanges are shipped with 1" gaskets.

LEAD-FREE

WATER METER DOWNSIZING HARDWARE

Replace a 2" turbine with a 2" compound meter

Meter Replacement Filler Flanges



2" Compound Meter

2" Compound Lay Length = 15-1/4"



2" Turbine Lay Length = 17"



PRODUCT NUMBER	NEW METER SIZE	OLD METER SIZE	QUANTITY TO USE
RH9079A	2" Compound	2" Turbine	1 Pack

All meter flanges are shipped with bolts & gaskets.

LEAD-FREE

WATER METER DOWNSIZING HARDWARE

Standard Meter Flanges

1-1/2" Standard Meter Flanges



2" Standard Meter Flanges



PRODUCT NUMBER	METER SIZE	CONNECTION TYPE	QUANTITY TO USE
RH200404P	1-1/2"	Flange x FEIP Thread	1 Pack
RH200505P	2"	Flange x FEIP Thread	1 Pack

All meter flanges are shipped with bolts & gaskets.

LEAD-FREE

WATER METER DOWNSIZING HARDWARE

Downsizing Reference Chart

PRODUCT NUMBER	NEW METER SIZE	OLD METER SIZE	CONNECTION TYPE	QUANTITY TO USE
RH1450	5/8"	5/8" x 3/4"	Flush Bushing	2 Each
RH1401	3/4"	5/8"	Meter Thread	2 Each
RH1402	5/8"	1"	Meter Thread	2 Each
RH1402	5/8" x 3/4"	1"	Meter Thread	2 Each
RH1430	3/4"	1"	Meter Thread	2 Each
RH1425	5/8" x 3/4"	3/4"	Meter Thread	1 Each
RH130402P	1"	1-1/2"	Coupling	2 Each
RH131501P	1"	1-1/2"	Bushing	2 Each
RH130502P	1"	2"	Coupling	2 Each
RH130201P	1"	2"	Bushing	2 Each
RH200402P	1"	1-1/2"	Flange x Meter Swivel	1 Pack
RH200504P	1-1/2"	2"	Flange x Flange	1 Pack
RH200201P	1"	2"	Flange x FEIP	1 Pack
RHFLSP130701	1"	3" Turbine	Flange x 1" Meter Thread	2 Each
RH9709A	2" Compound	2" Turbine	Flange x Flange	1 Pack

* Products highlighted in **RED** are for use with screwed-end meters only. *
Please call **1-866-4RED-HED** with any questions.

WATER METER DOWNSIZING HARDWARE

New Connection Reference Chart

PRODUCT NUMBER	NEW METER SIZE	CONNECTION TYPE	QUANTITY TO USE
RH200404P	1-1/2"	Flanged	1 Pack
RH200505P	2"	Flanged	1 Pack
RH13014	1-1/2"	Screwed-End	2 Each
RH13015	2"	Screwed-End	2 Each

* Products highlighted in **RED** are for use with screwed-end meters only. *
Please call **1-866-4RED-HED** with any questions.

WATER METER DOWNSIZING HARDWARE

High Density Polyethylene Pre-Fabricated Meter Pits

Lightweight But Strong

Our meter pits are made of high-density polyethylene and are exceptional for use in any non-traffic setting. Their light weight reduces labor costs with a one-man installation. A cast iron cover is included. Downsize inside or outside of the pit.

Wide Variety of Diameters & Options

Meter Pits come standard with compression inlets and outlets, however male or female thread, and flare connections are also available at no extra cost. Angle dual check valves are standard but we will gladly install any backflow per your specifications. Standard depth of bury is 5', deeper pits available upon request. Meter pits are always 100% customizable. Any pit can be made into a tandem or dual pit, just call and ask.

PRODUCT NUMBER	PIT DIAMETER	METER SIZE	INLET/OUTLET
MPI3012	20"	5/8"	3/4"
MPI3009	20"	3/4"	3/4"
MPI3003	20"	1"	1"
MPI3010	36"	1-1/2"	1-1/2"
MPI3005	36"	2"	2"



LEAD-FREE

WATER METER DOWNSIZING HARDWARE

High Density Polyethylene Pre-Fabricated Meter Pits

5/8" - 1" Meter Pit Cover

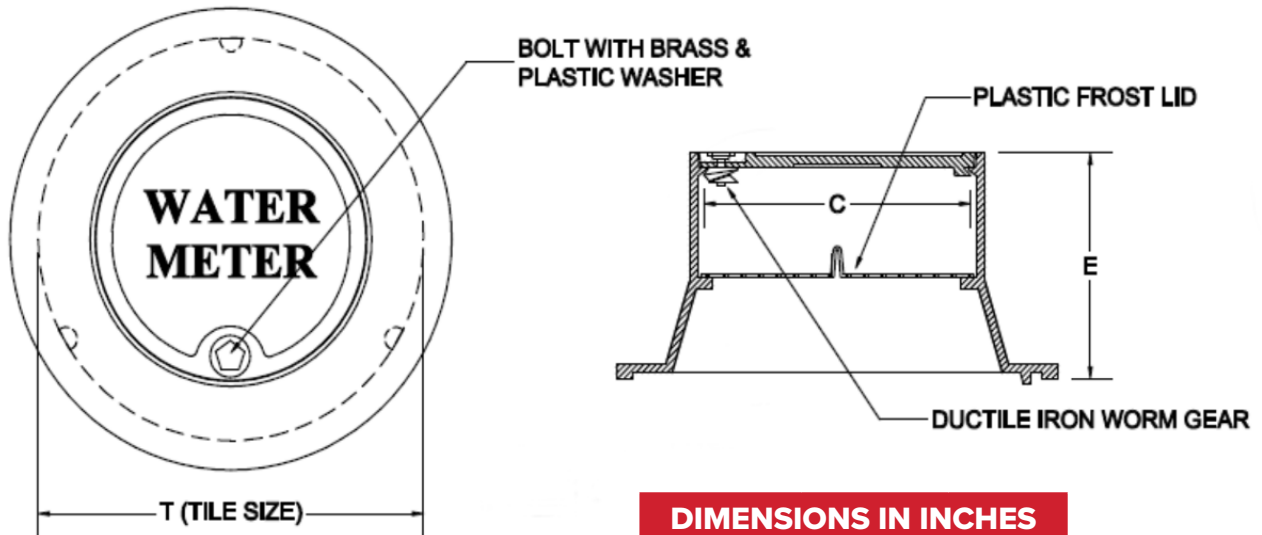

DIMENSIONS IN INCHES		
C	E	T
11-1/2"	9-1/2"	20"

1-1/2" - 2" Meter Pit Cover

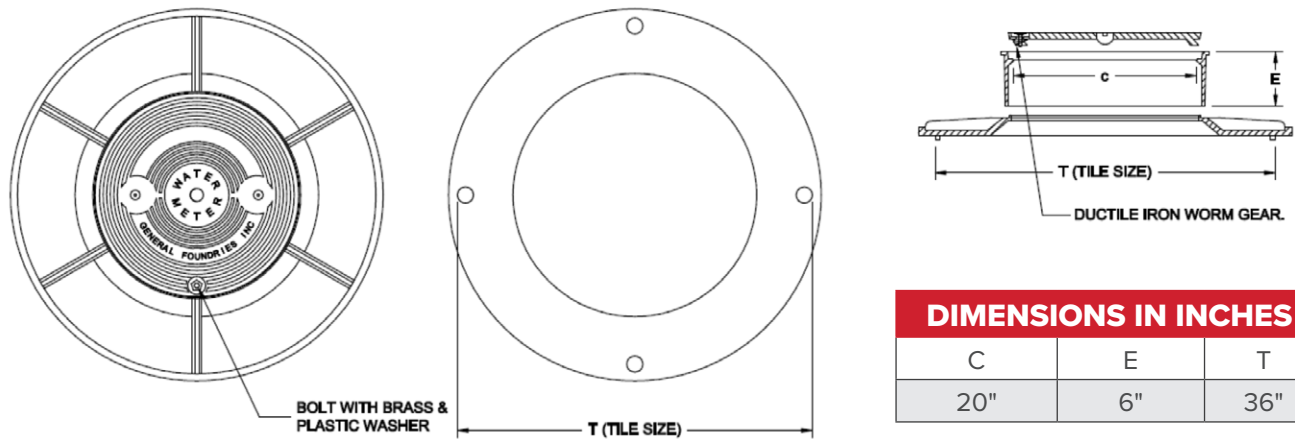

DIMENSIONS IN INCHES		
C	E	T
20"	6"	36"

LEAD-FREE

DOWNSIZING LARGER METERS

The Space Saver Flange

For downsizing meters larger than 2", **Red Hed** offers the **Space Saver Flange** (UL/FM Approved); a true **Red Hed** original. The **Space Saver Flange** is available in thirty-one standard sizes and, upon request, can be manufactured in any special size up to 24". In most cases, the flange is thinner than 2"! **Space Saver Flanges** can also be used to adapt from 150lb flange pattern to 250lb flange pattern and are also available in straight Metric or Metric x Standard sizes. All **Space Savers** are made in the USA of cast iron. Removable studs, nuts, and 1/8" thick SBR red rubber gaskets are always included.

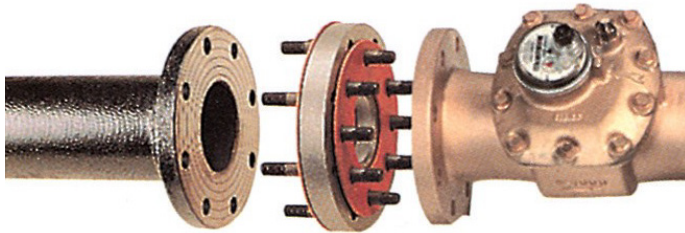

Above is a typical application for a **Space Saver Flange**. A smaller meter is installed in the same space previously occupied by a larger meter.

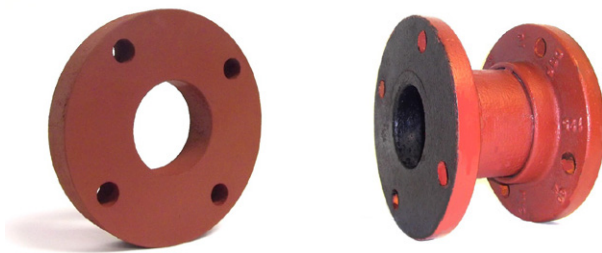
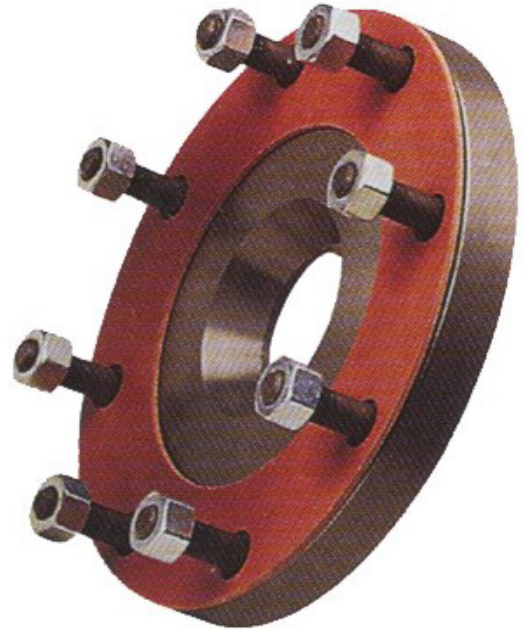

Unlike small meters, the lay lengths of larger meters may vary by manufacturer and/or type of meter. Therefore, it may be necessary to use a flange filler piece or flanged spool piece along with a **Space Saver Flange**. **Red Hed Manufacturing** proudly manufactures both for your convenience. We recommend that any filler flange or spool piece being used in conjunction with a Space Saver be used only on the larger side of the **Space Saver Flange**.

LEAD-FREE

Downsizing Larger Meters

Re-Sizing the Application

After considering the flow requirements of your application (see page 3), you will now have to compute the laying length to be filled by the new meter and the **Space Saver Flanges**. This will be a two-part calculation, simply enter your measurements into the formulas below.

Example Downsize Application

Replacing a 3" Compound with a 1-1/2" Compound

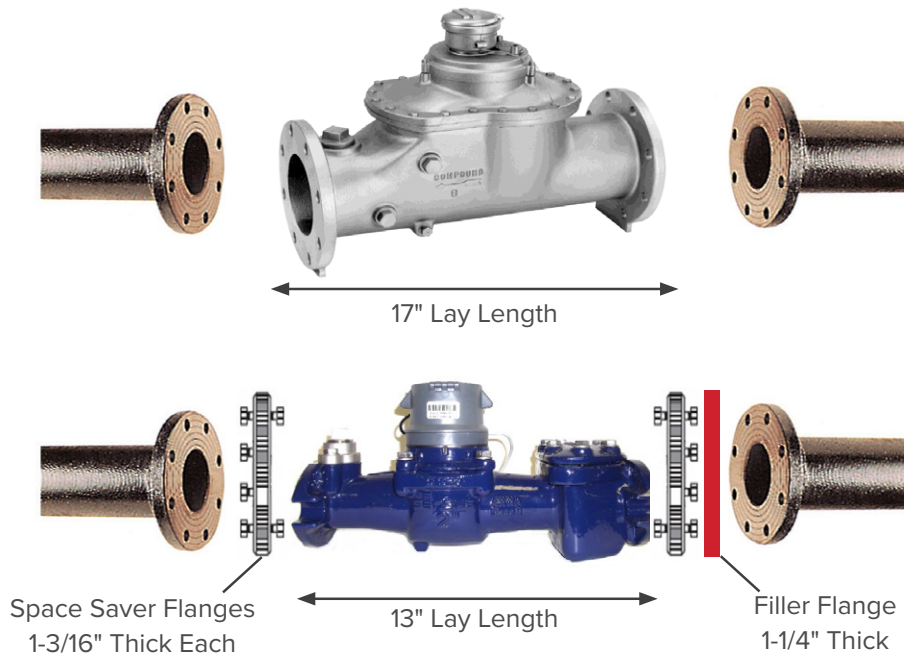

Step 1:

OLD LAY LENGTH	NEW LAY LENGTH	SPACE SAVER THICKNESS	2 GASKETS	=	ANNULAR SPACE
17"	13"	1-3/16" each or 2-3/8"	1/4"	=	1-3/8"
17"	13"	1.1875" each or 2.375"	0.25"	=	1.375"

As there is an annular space remaining, you will need a filler flange or spool piece to complete your installation. If the annular space is greater than 4", you will need a flanged spool piece.

Step 2:

OLD LAY LENGTH	NEW LAY LENGTH	SPACE SAVER THICKNESS	2 GASKETS	=	ANNULAR SPACE
17"	13"	1-3/16" each or 2-3/8"	1/4"	=	1-3/8"
17"	13"	1.1875" each or 2.375"	0.25"	=	1.375"

For this application you will need to order a 3" diameter filler flange, 1-1/4" thick along with your **Space Saver Flanges**.

Downsizing Larger Meters

Space Saver Flanges

PRODUCT NUMBER	SIZE	FLANGE DESCRIPTION	THICKNESS	WEIGHT
RHFLSP13062	2" x 2"	2 Bolt x 4 Bolt	13/16"	9lbs
RHFLSP130715	3" x 1-1/2"	Space Saver	1"	13lbs
RHFLSP13072	3" x 2"	Space Saver 2 Bolt	1"	13lbs
RHFLSP130724	3" x 2"	Space Saver 4 Bolt	1"	13lbs
RHFLSP130915	4" x 1-1/2"	Space Saver	1-3/16"	22lbs
RHFLSP13092	4" x 2"	Space Saver 2 Bolt	1-3/16"	22lbs
RHFLSP130924	4" x 2"	Space Saver 4 Bolt	1-3/16"	22lbs
RHFLSP130925	4" x 2-1/2"	Space Saver	1-3/16"	22lbs
RHFLSP13093	4" x 3"	Space Saver	1-3/16"	22lbs
RHFLSP1115	6" x 1-1/2"	Space Saver	1-3/16"	33lbs
RHFLSP13112	6" x 2"	Space Saver 2 Bolt	1-3/16"	33lbs
RHFLSP131124	6" x 2"	Space Saver 4 Bolt	1-3/16"	33lbs
RHFLSP131125	6" x 2-1/2"	Space Saver	1-3/16"	33lbs
RHFLSP13113	6" x 3"	Space Saver	1-3/16"	33lbs
RHFLSP13114	6" x 4"	Space Saver	1-3/16"	31lbs
RHFLSP13115	6" x 5"	Space Saver	2-1/4"	48lbs
RHFLSP13132	8" x 2"	Space Saver 2 Bolt	1-3/16"	48lbs
RHFLSP131324	8" x 2"	Space Saver 4 Bolt	1-3/16"	48lbs
RHFLSP13133	8" x 3"	Space Saver	1-3/16"	47lbs
RHFLSP13134	8" x 4"	Space Saver	1-3/16"	47lbs
RHFLSP13135	8" x 5"	Space Saver	1-3/16"	47lbs
RHFLSP13136	8" x 6"	Space Saver	1-3/16"	47lbs
RHFLSP13163	10" x 3"	Space Saver	1-7/16"	76lbs
RHFLSP13164	10" x 4"	Space Saver	1-7/16"	75lbs
RHFLSP13165	10" x 5"	Space Saver	1-7/16"	74lbs
RHFLSP13166	10" x 6"	Space Saver	1-7/16"	74lbs
RHFLSP13168	10" x 8"	Space Saver	1-7/16"	73lbs
RHFLSP13194	12" x 4"	Space Saver	1-1/2"	125lbs
RHFLSP13196	12" x 6"	Space Saver	1-1/2"	115lbs
RHFLSP13198	12" x 8"	Space Saver	1-1/2"	100lbs
RHFLSP131910	12" x 10"	Space Saver	1-1/2"	95lbs

All **Space Saver Flanges** are shipped with removable studs, nuts, and 1/8" thick SBR red rubber gaskets included. Stainless steel hardware available upon request.

TEAM
RED
HED 
BRASS MANUFACTURING

RED HED MANUFACTURING COMPANY

Division of Everett J. Prescott, Inc.

38 Albion Road, Route 123, Lincoln, RI 02865

401-333-1317 • 1-800-356-8605 • FAX: 401-333-9035

sales@redhedri.com • www.redhedri.com